

Z-11Pro
Automatic Antenna Tuner
Manual Version 1.0



LDG Electronics

1445 Parran Road, PO Box 48
St. Leonard MD 20685-2903 USA
Phone: 410-586-2177 Fax: 410-
586-8475 ldg@ldgelectronics.com
www.ldgelectronics.com

Introduction	3
Jumpstart, or “Real Hams Don’t Read Manuals!”	3
Specifications	4
<i>An Important Word About Power Levels</i>	4
Getting To Know Your Z-11Pro	5
Installation	6
<i>Installing An Internal Battery</i>	7
Operation	10
<i>Overview and Setup</i>	10
<i>Tuning Modes</i>	10
<i>Auto Tune Threshold</i>	10
<i>High.Low Impedance Toggle</i>	11
<i>Firmware Version Readout</i>	11
<i>EEPROM Reset</i>	11
<i>Tuning</i>	11
<i>Advanced Operation</i>	14
<i>Operation with an LDG Radio Interface</i>	14
Command Reference Chart	15
Application Notes	16
<i>Mobile Operation</i>	16
<i>When To Use Auto Mode</i>	16
<i>MARS/CAP Coverage</i>	16
Theory Of Operation	17
<i>Some Basic Ideas About Impedance</i>	17
<i>Transmitters, Transmission Lines, Antennas and Impedance</i>	17
The LDG Z-11Pro	19
Care and Maintenance	20
Technical Support	20
Warranty and Service	20
Feedback	21

Introduction

Congratulations on selecting the LDG Z-11Pro tuner. The Z-11Pro provides fully automatic, any-mode antenna tuning across the entire HF range plus 6 meters at power levels to 125 watts. It will tune dipoles, verticals, Yagis or virtually any coax-fed antenna. It will match an amazing range of antennas and impedances, far greater than some other tuners you may have considered. The Z-11Pro is designed with battery-powered operation in mind; it uses little power while tuning, and with its latching relays, uses essentially no power in standby.

While resembling earlier LDG tuners in overall layout and function, the Z-11Pro represents a quantum leap in features and performance. Enhanced tuning algorithms provide much faster, precise and consistent tuning. Automatic tuning is now available *during* transmission, even SSB, and user-settable options are accessible from the front panel. The LEDs show SWR and readouts of internal states and settings. LDG's exclusive 3-D memory provides virtually instant memory tuning for up to four different antennas.

LDG pioneered the automatic, wide-range switched-L tuner in 1995. From its laboratories near the nation's capitol, LDG continues to define the state of the art in this field with innovative automatic tuners and related products for every amateur need.

Jumpstart, or “Real Hams Don’t Read Manuals!”

Ok, but at least read this one section before you transmit:

- 1. Connect the antenna jack on your transceiver to the "TX" jack on your Z-11Pro tuner using a 50 Ohm coaxial cable jumper of appropriate power handling capability.**
- 2. Connect your 50 Ohm antenna coax lead to the "Ant" jack on the back of your Z-11Pro.**
- 3. Connect your Z-11Pro to a source of 8 - 16 volts DC @ 250mA via the 2.5 by 5.5 mm power jack on the back (center positive).**
- 4. Power up your transceiver and select the desired operating frequency.**
- 5. Begin transmitting, any mode¹.**
- 6. Wait for the tuning cycle to end.**
- 7. You're now ready to operate.**

Observe safety warning (page 4) and installation warning (page 6)

¹ If using SSB mode, simply speak into the microphone. You can tune while transmitting up to 125 watts if your transceiver has a “roll-back circuit” to protect it from high SWR. If it does not have a roll-back circuit, limit power when tuning to 25 watts to avoid damage to your transmitter, transceiver and/or tuner.

Specifications

- 0 to 125 watts SSB and CW peak power, 100 watts digital
- Easy to read LEDs indicate SWR and status
- 8000 "3-D" memories for instantaneous frequency or band changing
- Tuning time: 0.1 to 4 seconds full tune, < 0.1 second memory tune
- Built in frequency counter for memory operation
- Frequency coverage: 1.8 to 54.0 MHz.
- Tunes 6 to 1000 ohm loads (16 to 150 ohms on 6M), 6 to 4000 ohms with optional 4:1 Balun (LDG RBA-4:1)
- For Dipoles, Verticals, Vs, Beams or and Coax Fed Antenna
- Optional external Balun allows tuning of random length, long wire or ladder line fed antennas
- Optional interfaces for Icom, Alinco, Kenwood and Yaesu available
- Power requirements: 8 to 16 volts DC at 300 mA max during tuning, 25 uA idle
- Enclosure: 7.5 x 5.75 x 1.75 inches
- Weight: 1.5 pounds (no internal batteries)

An Important Word About Power Levels

The Z-11Pro is rated at 125 watts maximum power input *at most*. Many ham transmitters and transceivers, and virtually all amplifiers, output well over 125 watts. Power levels significantly exceeding specifications will definitely damage or destroy your Z-11Pro. If your tuner fails during overload, it could damage your transmitter or transceiver. Be sure to observe the specified power limitations.

IMPORTANT SAFETY WARNING

Never install antennas or transmission lines over or near power lines. You can be seriously injured or killed if any part of the antenna, support or transmission line touches a power line. Always follow this antenna safety rule: the distance to the nearest power line should be at least twice the length of the longest antenna, transmission line or support dimension.

Getting To Know Your Z-11Pro

Your Z-11Pro is a quality, precision instrument that will give you many years of outstanding service; take a few minutes to get to know it.

- Your Z-11Pro can be used with any transceiver or transmitter with coax output operating in the HF range at no more than 125 watts peak output. You can set the unit to tune automatically whenever the SWR exceeds a set value, or you can set it to tune semi-automatically when you start a tuning cycle by pressing the **Tune** button.



The front panel presents six pushbutton controls, and four LEDs:

- **Func**: Selects alternate functions for other buttons (see section on Operation)
- **C Up**: Manually increase capacitance
- **C Dn**: Manually decrease capacitance
- **L Up**: Manually increase inductance
- **L Dn**: Manually decrease inductance
- **Tune**: Initiates either a memory or full tuning cycle, places the tuner in "bypass" mode, and manually stores tuning parameters
- **LEDs**
 - 1.5: Green
 - 2.0: Yellow
 - >3.0: Red
 - Tune: Red

Your Z-11Pro has no power switch. It automatically powers up whenever RF is present or a button is pressed, and after tuning, automatically enters a "deep sleep" state in which it draws only 25 microamps, effectively off. The tuner will automatically "wake up" the next time you start a tuning cycle, a button is pressed or when an automatic tuning cycle is needed. The latching relays hold the tuned configuration indefinitely, even while DC power is completely removed. Tuning memories are stored indefinitely in EEPROM memory.

The Z-11Pro has a total of 8,000 3-D frequency memories. There are 2,000 memories for *each* of four separate antennas. When you transmit on or near a previously tuned frequency, you can use “Memory Tune” to reset the tuner in only a fraction of a second. The process of storing tuning settings in memory is completely automatic; your Z-11Pro “learns” as you use it, adapting itself to all of the bands and frequencies you use.

On the back panel, there are five connectors:

- RF input (marked “**TX**”, standard SO-239 connector)
- Antenna connector (marked “**Ant**”, standard SO-239 connector)
- DC power in (2.5 by 5.5 mm power jack marked “**Power**”, center positive)
- Stereo 1/8” jack marked “**Radio**” for connecting a control cable to a compatible transceiver
- Ground connector (wing nut)



Installation

Your Z-11Pro tuner is intended for indoor use only; it is not water resistant. If you use it outdoors (Field Day, for example) you must protect it from rain. The Z-11Pro is designed for use with coax-fed antennas. If you wish to use it with longwires or antennas fed with a balanced transmission line (e.g., ladder line), an external balun is required; either the LDG RBA-4:1 or RBA-1:1 is ideal, depending on the antenna and transmission line used.

Always turn your radio off before plugging or unplugging anything. Your radio may be damaged if you connect or disconnect a cable with the unit powered up. Note that some radios do not power down the tuner even when the radio is turned off. To be safe, unplug the tuner's power connector before plugging or unplugging anything else.

Connect the HF antenna jack on your transmitter or transceiver to the **TX** jack on the back of your Z-11Pro tuner using a coax jumper with standard PL-259 plugs (not provided). Properly soldered connectors will be far more satisfactory and reliable than crimp-on or “solderless” connectors. Attach your antenna lead-in coax to the **Ant** jack on the back of your Z-11Pro tuner.

Your Z-11Pro can interface directly with many popular transceivers, enabling their “Tune” button to start a tuning cycle (for Yaesu you'll use the **Tune** button on the tuner), and in most cases providing power to the tuner. Optional cables and interface adapters are available from LDG for Alinco (EDX-2), Icom (AH-4) and Kenwood (AT-300) compatible transceivers, and for the Yaesu FT-857(D) and FT-897(D). If you are using a transceiver interface, plug the adapter into the appropriate accessory jack on the radio, and plug the stereo plug on the interface adapter cable into the **Radio** jack on the back of the tuner.

If you are not using an interface cable to a radio capable of powering the tuner, connect your Z-11Pro to a source of DC power capable of providing 8 – 16 volts DC at 300 mA, using the provided 2.5x5.5mm coaxial cable (center positive). If your radio is powered by 12 VDC, you can use the same power supply for the Z-11Pro, providing the power supply can source the extra 300 mA required by the tuner during a tuning cycle. Note that the Yaesu interface cable does not power the radio.

Grounding your tuner will enhance its performance and safety. LDG recommends that you connect your tuner to a suitable ground; a dedicated ground rod connected to buried radials is preferred, but a single ground rod or a cold water pipe can provide a serviceable ground. LDG strongly recommends that you use a properly installed, high quality lightning arrestor on all antenna cables.

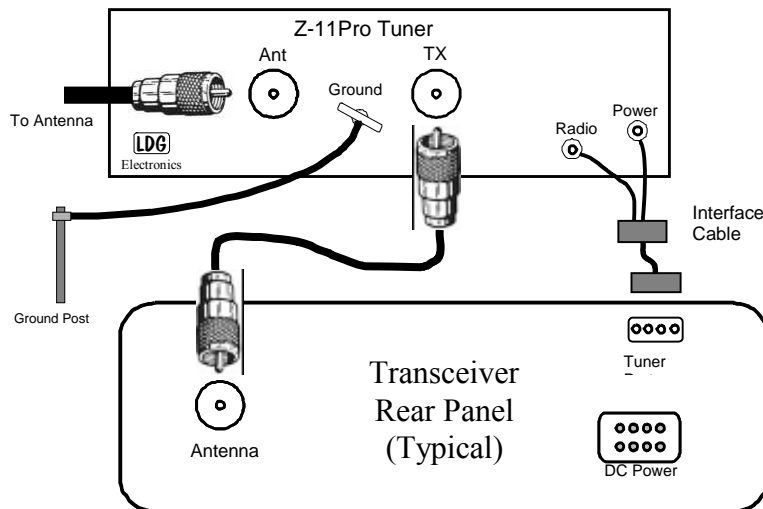

Installing An Internal Battery

Your Z-11Pro uses so little power it will run off many configurations of batteries, providing portable operation independent of AC power supplies. A 9 volt battery will power the unit for months of normal use, and six Alkaline batteries will last for years! You can plug your Z-11Pro into an external battery pack, but even better, you can install a battery *inside* your Z-11Pro, making it self-powered! Adapting your Z-11Pro to battery power involves only a few minor modifications.

Many battery options present themselves. Remember, your Z-11Pro will work well with as little as 8 volts. Let's assume that you'll make 20 tunes per day: 15 memory tunes and 5 full tunes. That amounts to 2 mAh per day². Here are some estimates of battery life for various combinations of cells:

Qty	Type	mAh	Days	Notes
One	9V NiMH	150	75	
One	9V Alkaline	600	300	
One	9V Lithium	1200	600	
Three	AA Lithium	2100	1050	(these are 3.6 volts each)
Six	AAA NiMH	850	425	
Six	AAA Alkaline	1150	575	
Six	AA NiMH	2000	1000	
Six	AA Alkaline	2850	1425	(almost 4 years!)

Note that these estimates do not account for self-discharge in NiMH batteries. Choose NiMH for more frequent or heavy use, Alkaline or Lithium for long shelf life. Lithium batteries are more expensive, but are quite a bit lighter than Alkalines of the same size, and you only need three 3.6 volt Lithium cells instead of six Alkalines. This makes them an attractive option for portable operation, adding minimal weight.

Suitable battery holders are readily available. Radio Shack (www.radioshack.com) sells holders for 4 and 8 cells. Mouser (www.mouser.com) and Digikey (www.digikey.com) sell holders for 2, 3, 4, 6 or 8 cells. These same sources can provide snap-on connectors for 9 volt batteries.

To install a battery or battery pack inside, disconnect your Z-11Pro. Open the case by removing the four screws (two on each side) and carefully lifting the top clear. You'll find room inside for the battery or battery pack on top of the relays; use double-sided foam tape to attach it there. There are two terminals on the Printed Circuit board for battery power. They are round lands with holes, immediately behind the DC power jack. The one directly behind the jack is for the Positive lead from the battery connector or holder (usually Red), the one offset slightly toward the center of the circuit board is for the Negative lead (usually Black; see the detail inset in the photo below). Carefully solder the leads into place, taking care to avoid solder "bridges" to other parts of the PC board. If you are using AA or AAA batteries in a holder, put a length of tape over them to keep them securely in their holder.

² The tuner draws 250 mA average while tuning and virtually no current while idle. Memory tunes take 0.1 seconds, full tunes 3 seconds on average. Your battery life will depend on how you operate, how often you tune, and whether you use full or memory tuning.

Replace the cover, being careful not to pinch or short the wires. You can use your Z-11Pro on external power even when batteries are installed, but the external power supply will not charge the batteries. You will need to remove any rechargeable batteries from the Z-11Pro and charge them in an external charger when needed.

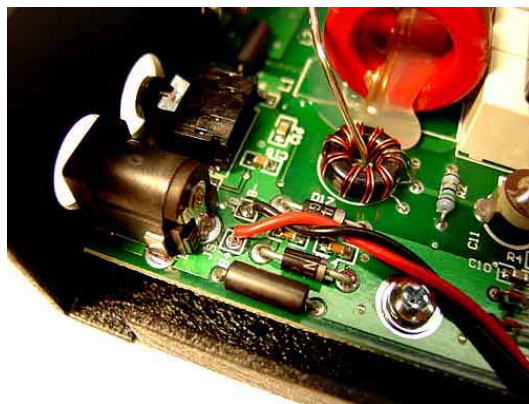

Modern batteries aren't very likely to leak, but why take the chance? If you won't be using your Z-11Pro for a month or more, remove all batteries and store them separately.



Operation

Overview and Setup



All functions are controlled through the six front panel buttons. Functions are generally invoked when a button is *released*, although in some cases you will hold a button down for a short time. Some commands are indicated by the length of time you hold a button before releasing it. There are three lengths of press: short (less than 0.4 seconds), medium (0.5 – 2.9 seconds) and long (more than 3 seconds). This sounds a lot more complicated than it really is; this interface will quickly become familiar and easy. The LEDs provide timing cues:

-  No LEDs lit: short press
-  Outer LEDs lit: medium press
-  Inner LEDs lit: long press





Four special functions are invoked with the **Func** button; the second function of these four buttons is indicated below each on the front panel. For these functions, press and release the **Func** button; the LEDs will scroll to the right to indicate **Func** mode. Then, press and release a button to invoke its second function. If you don't press another button within 3 seconds, the LEDs will scroll back to the left, indicating that the tuner has exited **Func** mode. You also use the **Func** button to check the settings. Press and hold the **Func** button while pressing the second button; the status of that function will be displayed on the LEDs.

Tuning Modes: Your Z-11Pro features two distinct tuning modes: Auto and Semi. In Auto mode, a tuning cycle will automatically begin whenever the SWR exceeds a threshold value; the default SWR threshold is 2.0, but you can set it to any SWR value between 1.5 and 3.0 (see below). In Semi mode a tuning cycle will begin *only* when you press and release the **Tune** button while transmitting, regardless of SWR. The default mode is Auto.

To toggle between Auto and Semi modes, press and release the **Func** button then press and release the **C Dn** button. The two inner LEDs will flash to indicate Auto mode, the two outer LEDs to indicate Semi-Auto mode. To check the setting, press and hold the **Func** button, then press and release the **C Dn** button.

-  Outer LEDs flash: Semi mode
-  Inner LEDs flash: Auto mode

Auto Tune Threshold: You can set the SWR threshold at which an automatic tuning cycle will begin. Press and release the **Func** button, then press and release the **L Dn** button. The first press of these buttons shows the current SWR threshold setting:

-  Green = 1.5
-  Green + Yellow = 1.7
-  Yellow = 2.0
-  Yellow + Red = 2.5
-  Red = 3.0

Repeat this button combination to cycle through the choices (lowest to highest, then wrap around). As soon as the selection is changed, the tuner is ready for operation.

High/Low Impedance Toggle:

You can manually set your Z-11Pro for Hi-Z or Lo-Z antennas. Press and release the **Func** button, then press and release the **L Up** button. Each such button sequence will toggle between High and Low. The Yellow LED indicates Low, the Red >3.0 LED High. Pressing **L Up** while holding **Func** will show the present setting. This function is rarely needed; it is available for the more advanced user to temporarily set the tuner to an L-C or C-L configuration. In any case, the setting is automatically configured the next time an Auto or Semi-Auto tuning cycle is run.

● ● ● ● Low Impedance

● ● ● ● High Impedance

Firmware Version Readout

You can read out the firmware version by pressing **Func + C Up + L Up** all at the same time. The green LED flashes the whole part of the number, the yellow LED flashes briefly to indicate the decimal point, then the red LED flashes the decimal part of the number. Example: Version 2.3 would be indicated by Green-Green-Yellow-Red-Red-Red³.

EEPROM Reset

You can clear all tuning memories and tuner settings by pressing **Func + C Dn + Tune**. All LEDs light, then go off in sequence right to left. Use this command with caution, as it erases all tuning memories and settings, and restores factory defaults. In other words, there is no "Are you sure?" step; Memory will be cleared as soon as you press these three buttons together.

Tuning

Auto and Semi modes

In Auto mode (see section on selection Auto or Semi mode) the tuner will begin a tuning cycle whenever the SWR exceeds the value you set (see section on setting Auto Tune Threshold). In Semi mode, a tuning cycle begins only when you start one by pressing the **Tune** button, regardless of SWR. You can also start a Semi tuning cycle while the tuner is in Auto mode. Your personal operating practices will determine which mode is best for you. The default mode is Auto (see Application Notes for more on when to use Auto mode).

Auto mode tuning works well while you are transmitting in SSB, AM, CW or any digital mode. Recent advances in LDG's tuning algorithms allow your Z-11Pro to tune effectively even with a varying RF signal. This means that as you change frequencies, modes, antennas or bands, you don't have to make a separate tuning transmission; just start talking or keying and your Z-11Pro will match up in as little as 0.1 seconds.

Memories

This is pretty amazing, so lash yourself to the mast: your Z-11Pro has 8,000 3-D frequency memories. These are "Continuous Q Matched" memories from 1.8 MHz to 54 MHz; there are more memories on lower frequencies where antenna Q is usually higher, and fewer memories on higher frequencies); there are four memories per frequency They store the tuning parameters for each frequency as you tune; that's 2,000 memories for *each* of *four* different antennas. You can use a wide variety of antennas, connecting them as needed. Just think of it; you could be using a Yagi, Quad, Loop, and Dipole and *each of them* will have 2,000 dedicated memories. When you transmit on or near a memorized frequency again, the tuner finds the best match for that antenna

³ This is only an example; your tuner may have a different firmware version.

and sets those parameters in a fraction of a second, much faster than a full tuning cycle. 3-D memory is an exclusive LDG technology, available only in LDG tuners.

When you tune using Semi mode, you can select between a Memory tune and a Full tune. If you select Memory tune and there is no appropriate memory data, the tuner will automatically begin a full tuning cycle. Tuning parameters are stored in EEPROM memory, and are retained indefinitely, even if power is removed. In Auto mode, Memory tune is used.

Using your Z-11Pro with the DTS-4 Intelligent Antenna Switch

3-D memories make switching among various antennas a breeze. Using LDG's DTS-4 Intelligent Desktop Antenna Switch, you can instantly connect up to four separate antennas with the press of a button. Your Z-11Pro will search it's 3-D memory bank for stored settings for *each* antenna and for the present frequency, and reset to them in less than 0.1 seconds. Working together, your Z-11Pro and DTS-4 Intelligent Antenna Switch makes switching and matching up to four antennas automatic and virtually instantaneous.

The small size of the DTS-4R remote control for the DTS-4 Intelligent Antenna Switch makes it especially appropriate for use with the compact Z-11Pro. The information on the next page shows how these two groundbreaking LDG products can be used together.

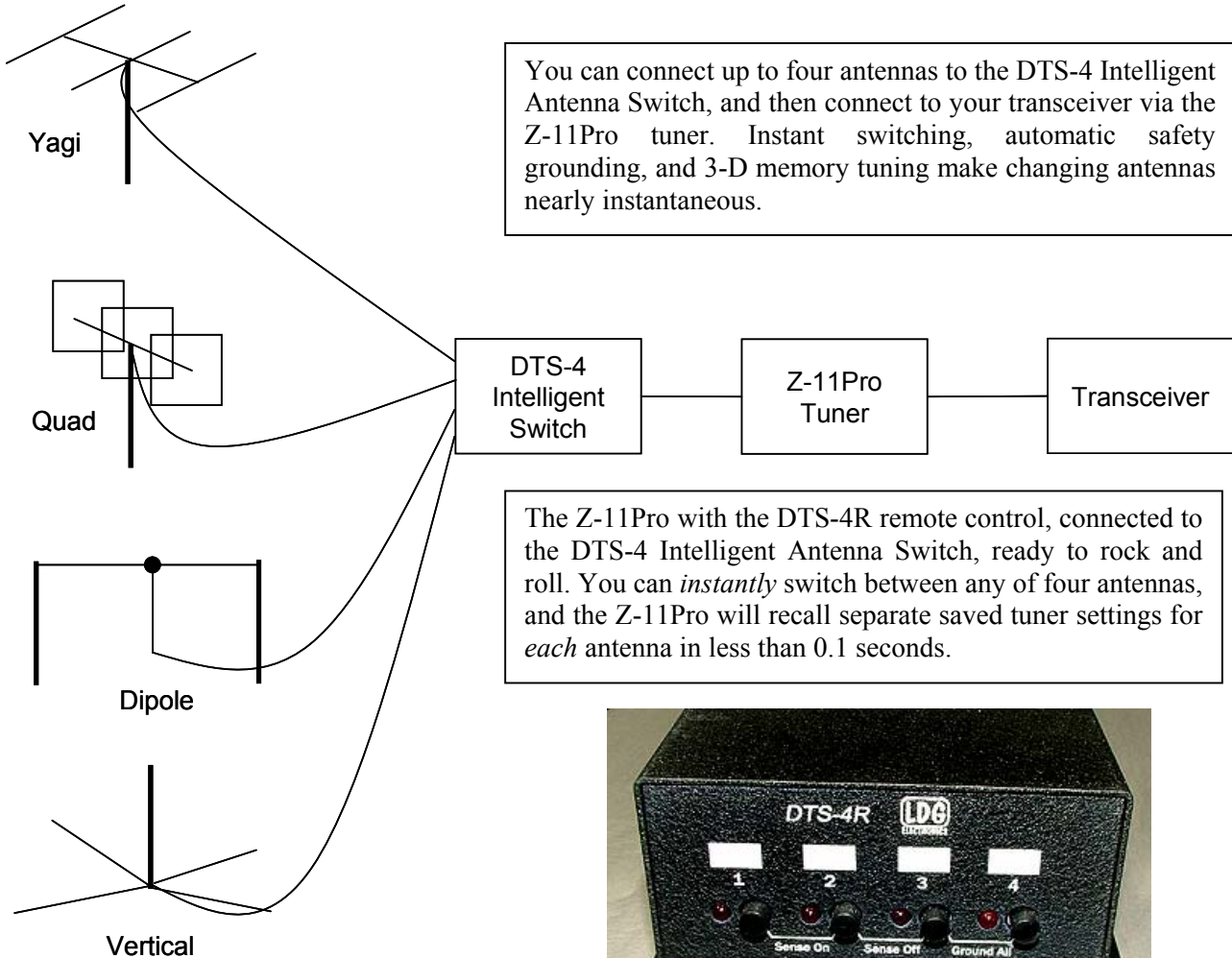

You can connect up to four antennas to the DTS-4 Intelligent Antenna Switch, and then connect to your transceiver via the Z-11Pro tuner. Instant switching, automatic safety grounding, and 3-D memory tuning make changing antennas nearly instantaneous.

The Z-11Pro with the DTS-4R remote control, connected to the DTS-4 Intelligent Antenna Switch, ready to rock and roll. You can *instantly* switch between any of four antennas, and the Z-11Pro will recall separate saved tuner settings for *each* antenna in less than 0.1 seconds.



Full tuning cycle (long press)

Set your transmitter or transceiver to SSB, AM, FM, CW or Packet mode, and a power level of no more than 125 watts if your radio has a power rollback circuit. If your radio lacks a rollback circuit (see your owner's manual), set the power level to no more than 25 watts.

Press the PTT switch on the microphone (close key on CW) to transmit a carrier, or simply begin talking on SSB or AM. While transmitting, press and hold the **Tune** button on the front of your Z-11Pro for at least 3 seconds (two inner LEDs lit).

Release the **Tune** button; a Semi-Auto tuning cycle will begin. The Tune LED will light and you will hear the relays in your Z-11Pro as they switch in and out seeking a match; they make a pretty loud buzzing noise. The tuning cycle will end in a few seconds with the LEDs indicating the final match. At the end of a full tuning cycle, the LEDs will scan inward from both ends to indicate a successful tune to an SWR of less than 1.5⁴, and will then indicate the final achieved SWR.

Unkey your transmitter or transceiver and reset to your desired power if you changed for tuning – you're ready to operate. The new tuning parameters are stored for the present operating frequency, replacing the oldest of the five parameters that were previously stored for that frequency, if any.

If you try to run a full tuning cycle when the SWR is already below the Auto tune threshold, the LEDs will blink twice to indicate you already have a match, and no tuning cycle will begin. If insufficient RF is present, all LEDs blink three times, and no tuning cycle will begin.

Memory tuning cycle (medium press)

If you are tuning near a frequency at which you have already completed a tuning cycle, you can reset the tuner very quickly by using a Memory Tuning Cycle. Key your transmitter as described above, and press and hold the Tune button for .5 to 2.9 seconds (two outer LEDs lit), then release. The tuner will automatically check for a saved tuning setting, and if present, will restore that setting in less than 0.1 seconds. If no tuned setting is saved near the present frequency, the tuner will begin a full tuning cycle, saving the result when finished for future operation on that frequency. In this way, your Z-11Pro "learns"; the longer you use it, the more closely it adapts itself to the bands and frequencies you use. If insufficient RF is present, all LEDs blink three times, and no tuning cycle will begin. You will probably use Memory Tuning most of the time; it takes advantage of any stored tuning settings, but automatically defaults to a Full Tuning cycle if no stored data is available

Bypass/Recall mode (short press)

To place your Z-11Pro in bypass mode, press the Tune button less than a half-second. The tuner will switch to bypass, and all LEDs will flash three times to confirm bypass mode. In bypass mode, RF from your transmitter goes directly to the antenna with no matching. A second short press recalls the last tuned setting; all LEDs flash once. Repeated button presses will toggle between bypass and recall; repeat as necessary. Bypass followed by **Func** then **Tune** will clear the present memory. Bypass mode is not saved when you power down. On the next power up, the tuner will reset the last tuned settings. You can, if you wish, press **Func** then **Tune** to save the bypass setting, erasing the oldest of the four memories for the present frequency.

⁴ LDG's chief engineer, a fan of Snoopy in the Peanuts comic strip, calls this the "Happy Dance".

SWR indication

During a tuning cycle, the LEDs indicate the present SWR. It will vary considerably as the Z-11Pro seeks a match. You have to watch closely though, as it happens fast!

"Sleep" mode

When any tuning cycle ends, the tuner automatically enters a "deep sleep" state in which it draws only 25 *microamps*. The tuner will automatically "wake up" the next time you start a tuning cycle, a button is pressed or when an automatic tuning cycle is required, if this option is selected.

Advanced Operation

Manual adjustments

In rare cases, it may be desirable to manually adjust the match after a tuning cycle. This will happen most often with antennas that are far from resonance at the operating frequency. The **C Up**, **C Dn**, **L Up** and **L Dn** buttons increase and decrease capacitance and inductance, respectively. To change these values, press repeatedly or hold any of these buttons. Then, key your transmitter to observe the achieved SWR on the SWR meter.

You can also manually change C and L as you transmit, observing the SWR on the LEDs. When you reach the limits of these adjustments, the LEDs blink: the inner LEDs indicate the high limit, outer LEDs low.

Frankly, you won't use these manual adjustments much. Your Z-11Pro is very, very good at finding a match. These functions are included only to provide you with the maximum utility and flexibility.

After manually adjusting the match, you can store the tuning parameters for the present frequency; press and release **Func**, then press and release **Tune**. The parameters are stored for later recall, replacing any the oldest of four saved parameters for that frequency.

Operation with an LDG Radio Interface

Operation with an optional LDG radio interface is easy. With the interface installed on an Alinco, Icom or Kenwood radio, simply press the Tuner or AT button on the radio; for Yaesu radios, press the Tune button *on the tuner* to begin an automatic tuning cycle. The radio will automatically transmit a 10 watt carrier⁵, and begin a Z-11Pro tuning cycle. Memory settings will be used if available, otherwise a full tuning cycle will run. When the tuning cycle ends, the radio will revert to its previous mode and power level.

⁵ Yaesu transceivers will transmit at the power level set in their options menu. Their rollback circuit will adjust output power as needed during the tune cycle.

Function	Button Strokes	LED Indications
Toggle Auto / Semi Modes	Func then C Dn	
Auto Tune Threshold	Func then L Dn	
Hi-Lo Z Select	Func then L Up	
Full Tune Cycle	Tune (long press)	
Memory Tuning Cycle	Tune (Medium press)	
Bypass/Restore	Tune (Short press)	<p>All LEDs Flash</p> <p>Bypass: 3 flashes</p> <p>Restore: 1 flash</p>
Firmware Version Readout	Func + C Up + L Up (Together)	<p>Example: 2.3</p>
Memory Reset	Func + C Dn + Tune (Together)	

Z-11Pro Command Reference

Application Notes

Mobile Operation

Your Z-11Pro is perfectly suited to mobile operation. You can install it under the dash along with your transceiver, or remotely in the trunk. The only requirements are that the tuner remain dry, and that you provide a fused source of DC power in accordance with the specifications. The Z-11Pro does not include an internal fuse; you must provide one in the DC line. LDG recommends a 2 Amp "fast blow" fuse. Make sure the tuner is well grounded to the car body.

To install the unit under the dash, you can "homebrew" a bracket (LDG does not provide one). You can also use Velcro tape, although the adhesive tends to soften in hot weather. In the trunk, Velcro works well to secure the unit to the trunk floor. Simply run coax from your transceiver to the tuner, run a fused DC line to the tuner and connect your mobile antenna. Set the tuner to Automatic mode, and you're ready to go. The tuner will adjust the match as needed whenever you transmit on a new band or frequency. You can observe the progress of the match on your rig's SWR meter or on the Z-11Pro's LEDs (*not* while driving; keep your eyes on the road!). When the reading stops changing, the tuner has finished tuning. Most of the time this will happen very quickly as the Z-11Pro tunes from memory in a fraction of a second.

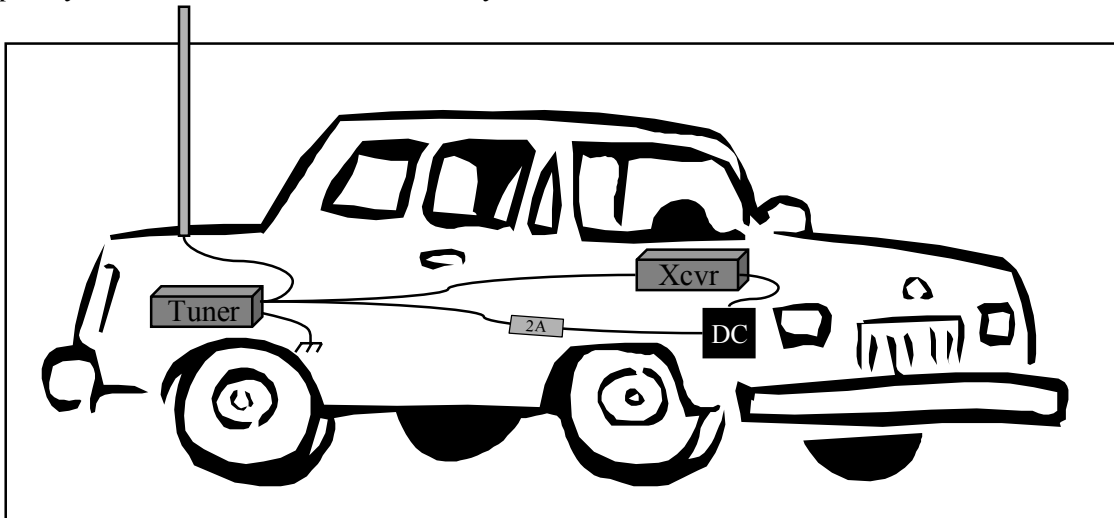

When To Use Auto Mode

Auto mode is most useful when you are often changing frequencies and bands (a contest, for instance). With memory operation, Auto mode will retune almost instantly whenever you transmit on a new frequency. On the other hand, if your antenna SWR is relatively flat across the band of frequencies you're using, retuning might not be necessary, and semi-automatic mode would be preferable.

MARS/CAP Coverage

Your Z-11Pro provides continuous tuning over its specified range, not just in the ham bands. This makes it useful for MARS or CAP operation, or any other legal HF operation.

Theory Of Operation

Some Basic Ideas About Impedance

The theory underlying antennas and transmission lines is fairly complex, and in fact employs a mathematical notation called “complex numbers” that have “real” and “imaginary” parts. It is beyond the scope of this manual to present a tutorial on this subject⁶, but a little background will help you understand what your Z-11Pro is doing, and how it does it.

In simple DC circuits, the wire resists the current flow, converting some of it into heat. The relationship between voltage, current and resistance is described by the elegant and well-known “Ohm’s Law”, named for Georg Simon Ohm of Germany, who first discovered it in 1826. In RF circuits, an analogous but far more complicated relationship exists.

RF circuits also resist the flow of electricity. However, the presence of capacitive and inductive elements causes the voltage in the circuit to lead or lag the current, respectively. In RF circuits this resistance to the flow of electricity is called “impedance”, and can include all three elements: resistive, capacitive, and inductive.



The output circuit of your transmitter consists of inductors and capacitors, usually in a series/parallel configuration called a “pi network”. The transmission line can be thought of as a long string of capacitors and inductors in series/parallel, and the antenna is a kind of resonant circuit. At any given RF frequency, each of these can exhibit resistance and impedance in the form of capacitive or inductive “reactance”.

Transmitters, Transmission Lines, Antennas and Impedance

The output circuit of your transmitter, the transmission line, and the antenna all have a characteristic impedance. For reasons too complicated to go into here, the standard impedance is about 50 ohms resistive, with zero capacitive and inductive components. When all three parts of the system have the same impedance, the system is said to be “matched”, and maximum transfer of power from the transmitter to the antenna occurs. While the transmitter output circuit and transmission line are of fixed, carefully designed impedance, the antenna presents a 50 ohm, non-reactive load only at its natural resonant frequencies. At other frequencies, it will exhibit capacitive or inductive reactance, causing it to have an impedance other than 50 ohms.

When the impedance of the antenna is different from that of the transmitter and transmission line, a “mismatch” is said to exist. In this case, some of the RF energy from the transmitter is reflected from the antenna back down the transmission line, and into the transmitter. If this reflected energy is strong enough it can damage the transmitter’s output circuits.

The ratio of transmitted to reflected energy is called the “standing wave ratio”, or SWR. An SWR of 1 (sometimes written 1:1) indicates a perfect match. As more energy is reflected, the SWR

⁶ For a very complete explanation of this subject, see any edition of the ARRL Handbook for Radio Communications (previously the Handbook For Radio Amateurs).

risers to 2, 3 or higher. As a general rule, modern solid state transmitters must operate with an SWR of 2 or less. Tube excitors are somewhat more tolerant of high SWR. If your 50 ohm antenna is resonant at your operating frequency, it will show an SWR close to 1. However, this is usually not the case; operators often need to transmit at frequencies other than resonance, resulting in a reactive antenna and a higher SWR.

$$SWR = \frac{1 + \sqrt{R/F}}{1 - \sqrt{R/F}} \quad \text{where F = Forward power (watts), R = Reflected power (watts)}$$

SWR is measured using a device called an “SWR bridge”, inserted in the transmission line between the transmitter and antenna. This circuit measures forward and reverse power from which SWR may be calculated (some meters calculate SWR for you). More advanced units can measure forward and reverse power simultaneously, and show these values and SWR at the same time.

An antenna tuner is a device used to cancel out the effects of antenna reactance. Tuners add capacitance to cancel out inductive reactance in the antenna, and vice versa. Simple tuners use variable capacitors and inductors; the operator adjusts them by hand while observing reflected power on the SWR meter until a minimum SWR is reached. Your LDG Z-11Pro automates this process.

No tuner will fix a bad antenna. If your antenna is far from resonance, the inefficiencies inherent in such operation are inescapable; it’s simple physics. Much of your transmitted power may be dissipated in the tuner as heat, never reaching the antenna at all. A tuner simply “fools” your transmitter into behaving as though the antenna were resonant, avoiding any damage that might otherwise be caused by high reflected power. Your antenna should always be as close to resonance as practical.

		Forward Power (Watts)								
		20	30	40	50	60	70	80	90	100
2	Reflected Power (Watts)	1.92	1.70	1.58	1.50	1.45	1.41	1.38	1.35	1.33
4		2.62	2.15	1.92	1.79	1.70	1.63	1.58	1.53	1.50
6		3.42	2.62	2.26	2.06	1.92	1.83	1.75	1.70	1.65
8		4.44	3.14	2.62	2.33	2.15	2.02	1.92	1.85	1.79
10		5.83	3.73	3.00	2.62	2.38	2.22	2.09	2.00	1.92
12		7.87	4.44	3.42	2.92	2.62	2.41	2.26	2.15	2.06
14		11.24	5.31	3.90	3.25	2.87	2.62	2.44	2.30	2.20
16		17.94	6.42	4.44	3.60	3.14	2.83	2.62	2.46	2.33
18		37.97	7.87	5.08	4.00	3.42	3.06	2.80	2.62	2.47
20		-	9.90	5.83	4.44	3.73	3.30	3.00	2.78	2.62
22		-	12.92	6.74	4.94	4.07	3.55	3.21	2.96	2.77
24		-	17.94	7.87	5.51	4.44	3.83	3.42	3.14	2.92
26		-	27.96	9.32	6.17	4.85	4.12	3.65	3.32	3.08
28		-	57.98	11.24	6.95	5.31	4.44	3.90	3.52	3.25
30		-	-	13.93	7.87	5.83	4.79	4.16	3.73	3.42
32		-	-	17.94	9.00	6.42	5.18	4.44	3.95	3.60
34		-	-	24.63	10.40	7.09	5.60	4.75	4.19	3.80
36		-	-	37.97	12.20	7.87	6.07	5.08	4.44	4.00
38		-	-	77.99	14.60	8.80	6.60	5.44	4.71	4.21
40		-	-	-	17.94	9.90	7.19	5.83	5.00	4.44
42		-	-	-	22.96	11.24	7.87	6.26	5.31	4.68
44		-	-	-	31.30	12.92	8.65	6.74	5.65	4.94
46		-	-	-	47.98	15.08	9.56	7.27	6.02	5.22
48		-	-	-	97.99	17.94	10.63	7.87	6.42	5.51
50		-	-	-	-	21.95	11.92	8.55	6.85	5.83

SWR Lookup Table
Find SWR at intersection of
forward power column and
reflected power row.

The LDG Z-11Pro

In 1995 LDG pioneered a new type of automatic antenna tuner. The LDG design uses banks of fixed capacitors and inductors, switched in and out of the circuit by relays under microprocessor control. A built-in SWR sensor provides feedback while the microprocessor searches the capacitor and inductor banks, seeking the lowest possible SWR. The tuner is a “Switched L” network consisting of series inductors and parallel capacitors. LDG chose the L network for its minimum number of parts and its ability to tune unbalanced loads, such as coax-fed dipoles, verticals, Yagis or virtually any coax-fed antenna. The inductors are switched in and out of the circuit by relays controlled by the microprocessor. An additional relay switches between high and low impedance ranges.

The capacitors are connected to ground with the inductor relays. Another relay switches the entire capacitor bank to the input or output side of the inductor. This switching allows the Z-11Pro to automatically handle loads that are greater than 50 ohms (high setting) and less than 50 (low setting).

The SWR sensor is a variation of the Bruene circuit. This SWR measuring technique is used in most dual-meter and direct-reading SWR meters. Slight modifications were made to the circuit to provide voltages (instead of currents) for the analog-to-digital converters (ADCs) that provide signals proportional to the forward and reverse power levels. The single-lead primary through the center of the sensor transformer provides RF current sampling. Diodes rectify the sample and provide a DC voltage proportional to RF power. Variable resistors calibrate the FORWARD and REVERSE power levels. Once adjusted, the forward and reverse power sensors produce a calibrated DC voltage proportional to the forward and reverse RF power levels. These two voltages are read by the ADCs in the microprocessor. Once in a digital format, they are used to calculate SWR in real time.

The relays operate from DC supplied by the power input jack. The total current drawn by the Z-11Pro depends primarily on the number of energized relays, with the maximum current drain being approximately 300 mA, but only during the few seconds a tuning cycle is running. At all other times, the tuner is in a “deep sleep” mode drawing only a few milliamps. The last tuned setting is automatically reset on the next power-up.

The microprocessor’s oscillator runs at 20 MHz. The main tuning routine takes about 75 cycles to make a tuner adjustment and take a new SWR measurement, or 7 milliseconds per tuner adjustment. If running at maximum speed, the microprocessor can try all inductor-capacitor combinations in under 3 seconds. Unfortunately, the mechanical relays can’t react as quickly as the microprocessor, and the tuning speed must be slowed down to compensate for relay settling time.

The tuning routine includes an algorithm to minimize the number of tuner adjustments. The routine first de-energizes the high/low impedance relay if necessary, then individually steps through the inductors to find a coarse match. With the best inductor selected, the tuner then steps through the individual capacitors to find the best coarse match. If no match is found, the routine repeats the coarse tuning with the high/low impedance relay energized. The routine then fine tunes the capacitors and inductors. The program checks LC combination to see if a 1.5 or lower SWR can be obtained, and stops when it finds a good match.

The microprocessor runs a fine tune routine just after the tuner finds a match at an SWR of 1.5 or less. This routine tries to get the SWR as low as possible (not just 1.5); it takes about a half

second to run. There is also a quick tune mode. If the SWR is below 2.0 when you press the tune button to start a tuning cycle, the tuner will first try a memory tune routine to see if it can achieve a low SWR without a complete re-tune. This also takes about a half second to run. If it does not find a good match, then it runs a full tuning routine.

A Word About Tuning Etiquette

Be sure to use a vacant frequency to tune. With today's crowded ham bands, this is often difficult. However, do your best to avoid interfering with other hams as you tune. Your Z-11Pro's very short tuning cycle, often only a fraction of a second, minimizes the impact of your tuning transmissions. Tune at reduced power whenever possible; one or two watts is plenty.

Care and Maintenance

Your Z-11Pro tuner is essentially maintenance-free; just be sure to observe the power limits discussed in this manual. The outer case may be cleaned as needed with a soft cloth slightly dampened in household cleaning solution. As with any modern electronic device, your Z-11Pro can be damaged by temperature extremes, water, impact or static discharge. LDG strongly recommends that you use a good quality, properly installed lightning arrestor in the antenna lead.

Technical Support

We are happy to help you with your Z-11Pro. Telephone technical support is available at 410-586-2177 weekdays from 9 am to 5pm Eastern Time. Inquiries by Fax at 410-586-8475 are welcome, and prompt e-mail support is available at ldg@ldgelectronics.com.

Warranty and Service

Your Z-11Pro is warranted against defects in parts or workmanship for two years from purchase. The warranty does not cover damage due to abuse or exceeding specifications. This warranty applies to the original purchaser only; it is not transferable. A copy of the receipt showing the purchaser's name and the date of purchase must accompany units returned for warranty service. All returns must be shipped to us pre-paid; we will not accept units with postage due. A return form is provided on our web site for your convenience.

If you need to return your Z-11Pro to us for service, package it carefully, keeping in mind that we will re-use your packaging to return the unit to you. Download the return form from our web site (ldg@ldgelectronics.com), fill it out and return it with your tuner. A self-addressed return-shipping label, while not required, will help insure speedy and accurate delivery of your repaired unit. Include a full description of the problem, along with your name, address and a phone number or e-mail address where we can reach you with any questions. Repairs average about 3 to 6 weeks.

We will be glad to service your Z-11Pro after the warranty period has ended. We will notify you of repair charges by phone or e-mail, and bill you after repairs are completed.

Firmware Upgrades

From time to time LDG may release upgraded firmware for the Z-11Pro, refining operation and adding features. Your Z-11Pro is not field programmable. You will have to remove the present

chip and replace it with the upgrade chip. Upgrades are expected to cost about \$10-\$20, and will be announced on our web site when available.

Feedback

If you have an idea to improve our software or hardware, please send us a description. If we incorporate your idea in the Z-11Pro, we'll send you a free upgrade as a "thank you".

We encourage everyone who uses the Z-11Pro to contact us (card, letter or e-mail preferred) telling us how well it works for you. We are also always looking for photographs of our products in use. We frequently place such pictures on our Web site (www.ldgelectronics.com).

